

Mormax is your provider for customizable, versatile line of power and data charging solutions. We house a variety of stock in NY with larger and custom projects manufactured in China. All units are UL Certified, customizable and quick to install. Mormax is here to help you pick the perfect power and data charging solution for your projects.



Features & Benefits

- 2 Tamper Resistant AC Outlets
- 10 ft. Power Cord
- Applicable voltage: 120 VAC / current: 15 Amp
- Power cable: 90 degree with 45 degree offset
- ABS (plastic) Material
- UL/CUL Listed for mounting in furniture

Product Information

Product Number	PS20BK
Dimensions (L*W*H)	4.933" x 1.575" x 1.456"
Weight	1.53 lbs
Warranty	1 Year



Top

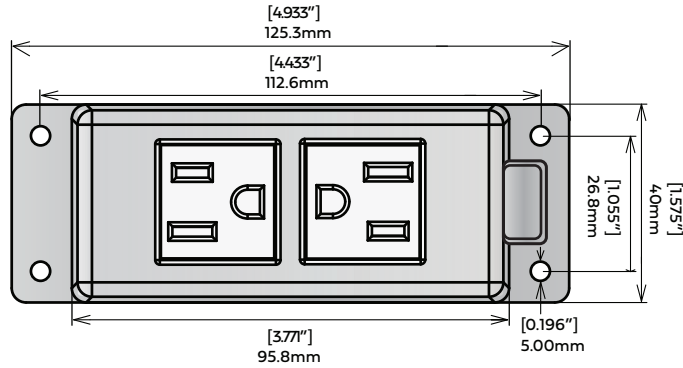

Front

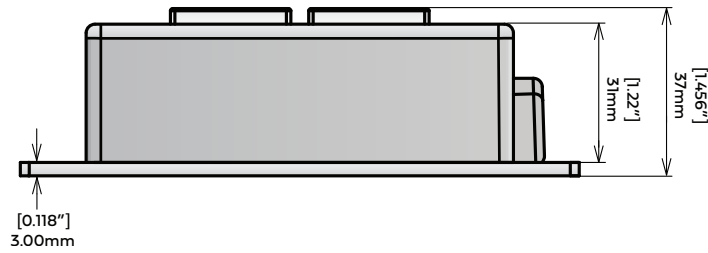

Side (L)

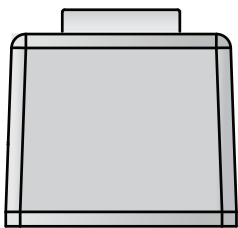

Side (R)

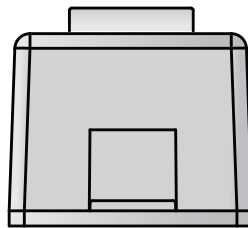

Plug

